

Dual Long-Tailed Pair Transistor Array

The HFA3102 is an all NPN transistor array configured as dual differential amplifiers with tail transistors. Based on Intersil bonded wafer UHF-1 SOI process, this array achieves very high f_T (10GHz) while maintaining excellent h_{FE} and V_{BE} matching characteristics over temperature. Collector leakage currents are maintained to under 0.01nA.

Ordering Information

PART NUMBER	TEMP. RANGE (°C)	PACKAGE	PKG. NO.
HFA3102B	-40 to 85	14 Ld SOIC	M14.15
HFA3102B96	-40 to 85	14 Ld SOIC Tape and Reel	M14.15

Pinout/Functional Diagram

HFA3102
(SOIC)
TOP VIEW

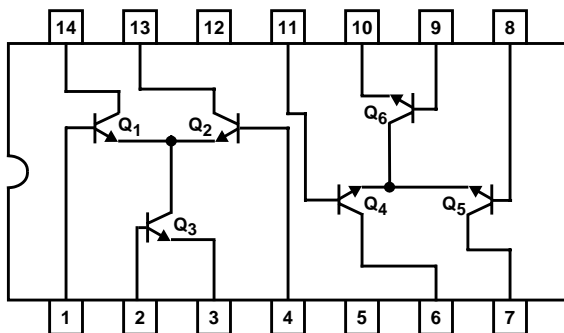

Features

- High Gain-Bandwidth Product (f_T) 10GHz
- High Power Gain-Bandwidth Product 5GHz
- High Current Gain (h_{FE}) 70
- Noise Figure (Transistor) 3.5dB
- Low Collector Leakage Current <0.01nA
- Excellent h_{FE} and V_{BE} Matching
- Pin-to-Pin to UPA102G

Applications

- Single Balanced Mixers
- Wide Band Amplification Stages
- Differential Amplifiers
- Multipliers
- Automatic Gain Control Circuits
- Frequency Doublers, Triplers
- Oscillators
- Constant Current Sources
- Wireless Communication Systems
- Radio and Satellite Communications
- Fiber Optic Signal Processing
- High Performance Instrumentation

HFA3102

Absolute Maximum Ratings $T_A = 25^\circ\text{C}$

V_{CEO} Collector to Emitter Voltage	8.0V
V_{CBO} Collector to Base Voltage	12.0V
V_{EBO} Emitter to Base Voltage	12.0V
I_C , Collector Current	30mA

Operating Conditions

Temperature Range -40°C to 85°C

Thermal Information

Thermal Resistance (Typical, Note 1)	θ_{JA} ($^\circ\text{C}/\text{W}$)
SOIC Package	125
Maximum Power Dissipation at 75°C	
Any One Transistor	0.25W
Maximum Junction Temperature (Die)	175°C
Maximum Junction Temperature (Plastic Package)	150°C
Maximum Storage Temperature Range	-65°C to 150°C
Maximum Lead Temperature (Soldering 10s)	300°C
(SOIC - Lead Tips Only)	

CAUTION: Stresses above those listed in "Absolute Maximum Ratings" may cause permanent damage to the device. This is a stress only rating and operation of the device at these or any other conditions above those indicated in the operational sections of this specification is not implied.

NOTE:

- θ_{JA} is measured with the component mounted on an evaluation PC board in free air.

Electrical Specifications $T_A = 25^\circ\text{C}$

SYMBOLS	PARAMETER	TEST CONDITIONS	(NOTE 2) TEST LEVEL	ALL GRADES			UNITS	
				MIN	TYP	MAX		
$V_{(BR)CBO}$	Collector-to-Base Breakdown Voltage (Q ₁ , Q ₂ , Q ₄ , and Q ₅)	$I_C = 100\mu\text{A}$, $I_E = 0$	A	12	18	-	V	
$V_{(BR)CEO}$	Collector-to-Emitter Breakdown Voltage (Q ₁ thru Q ₆)	$I_C = 100\mu\text{A}$, $I_B = 0$	A	8	12	-	V	
$V_{(BR)EBO}$	Emitter-to-Base Breakdown Voltage (Q ₃ and Q ₆)	$I_E = 50\mu\text{A}$, $I_C = 0$	A	5.5	6	-	V	
I_{CBO}	Collector Cutoff Current (Q ₁ , Q ₂ , Q ₄ , and Q ₅)	$V_{CB} = 5\text{V}$, $I_E = 0$	A	-	0.1	10	nA	
I_{EBO}	Emitter Cutoff Current (Q ₃ and Q ₆)	$V_{EB} = 1\text{V}$, $I_C = 0$	A	-	-	100	nA	
h_{FE}	DC Current Gain (Q ₁ thru Q ₆)	$I_C = 10\text{mA}$, $V_{CE} = 3\text{V}$	A	40	70	-	-	
C_{CB}	Collector-to-Base Capacitance	$V_{CB} = 5\text{V}$, $f = 1\text{MHz}$	B	-	300	-	fF	
C_{EB}	Emitter-to-Base Capacitance	$V_{EB} = 0$, $f = 1\text{MHz}$	B	-	200	-	fF	
f_T	Current Gain-Bandwidth Product	$I_C = 10\text{mA}$, $V_{CE} = 5\text{V}$	C	-	10	-	GHz	
f_{MAX}	Power Gain-Bandwidth Product	$I_C = 10\text{mA}$, $V_{CE} = 5\text{V}$	C	-	5	-	GHz	
G_{NFMIN}	Available Gain at Minimum Noise Figure	$I_C = 3\text{mA}$, $V_{CE} = 3\text{V}$	$f = 0.5\text{GHz}$	C	-	17.5	-	dB
			$f = 1.0\text{GHz}$	C	-	12.4	-	dB
NF_{MIN}	Minimum Noise Figure	$I_C = 3\text{mA}$, $V_{CE} = 3\text{V}$	$f = 0.5\text{GHz}$	C	-	1.8	-	dB
			$f = 1.0\text{GHz}$	C	-	2.1	-	dB
$NF_{50\Omega}$	50 Ω Noise Figure	$I_C = 3\text{mA}$, $V_{CE} = 3\text{V}$	$f = 0.5\text{GHz}$	C	-	3.3	-	dB
			$f = 1.0\text{GHz}$	C	-	3.5	-	dB
h_{FE1}/h_{FE2}	DC Current Gain Matching (Q ₁ and Q ₂ , Q ₄ and Q ₅)	$I_C = 10\text{mA}$, $V_{CE} = 3\text{V}$	A	0.9	1.0	1.1	-	
V_{OS}	Input Offset Voltage (Q ₁ and Q ₂), (Q ₄ and Q ₅)	$I_C = 10\text{mA}$, $V_{CE} = 3\text{V}$	A	-	1.5	5	mV	
I_{OS}	Input Offset Current (Q ₁ and Q ₂), (Q ₄ and Q ₅)	$I_C = 10\text{mA}$, $V_{CE} = 3\text{V}$	A	-	5	25	μA	

HFA3102

Electrical Specifications $T_A = 25^\circ\text{C}$ (Continued)

SYMBOLS	PARAMETER	TEST CONDITIONS	(NOTE 2) TEST LEVEL	ALL GRADES			UNITS
				MIN	TYP	MAX	
dV_{OS}/dT	Input Offset Voltage TC (Q_1 and Q_2 , Q_4 and Q_5)	$I_C = 10\text{mA}$, $V_{CE} = 3\text{V}$	C	-	0.5	-	$\mu\text{V}/^\circ\text{C}$
$I_{\text{TRENCH-LEAKAGE}}$	Collector-to-Collector Leakage (Pin 6, 7, 13, and 14)	$\Delta V_{\text{TEST}} = 5\text{V}$	B	-	0.01	-	nA

NOTE:

2. Test Level: A. Production Tested; B. Typical or Guaranteed Limit Based on Characterization; C. Design Typical for Information Only

PSPICE Model for a Single Transistor

.Model NUHFARRY NPN

```

+ ( IS= 1.840E-16  XTI= 3.000E+00  EG= 1.110E+00  VAF= 7.200E+01
+ VAR= 4.500E+00  BF= 1.036E+02  ISE= 1.686E-19  NE= 1.400E+00
+ IKF= 5.400E-02  XTB= 0.000E+00  BR= 1.000E+01  ISC= 1.605E-14
+ NC= 1.800E+00  IKR= 5.400E-02  RC= 1.140E+01  CJC= 3.980E-13
+ MJC= 2.400E-01  VJC= 9.700E-01  FC= 5.000E-01  CJE= 2.400E-13
+ MJE= 5.100E-01  VJE= 8.690E-01  TR= 4.000E-09  TF= 10.51E-12
+ ITF= 3.500E-02  XTF= 2.300E+00  VTF= 3.500E+00  PTF= 0.000E+00
+ XCJC= 9.000E-01  CJS= 1.689E-13  VJS= 9.982E-01  MJS= 0.000E+00
+ RE= 1.848E+00  RB= 5.007E+01  RBM= 1.974E+00  KF= 0.000E+00
+ AF= 1.000E+00)

```

Common Emitter S-Parameters

 $V_{CE} = 5V$ and $I_C = 5mA$

FREQ. (Hz)	S ₁₁	PHASE(S ₁₁)	S ₁₂	PHASE(S ₁₂)	S ₂₁	PHASE(S ₂₁)	S ₂₂	PHASE(S ₂₂)
1.0E+08	0.833079	-11.7873	1.418901E-02	78.8805	11.0722	168.576	0.976833	-11.0509
2.0E+08	0.791776	-22.8290	2.695740E-02	68.6355	10.5177	157.897	0.930993	-21.3586
3.0E+08	0.734911	-32.6450	3.750029E-02	59.5861	9.75379	148.443	0.868128	-30.4451
4.0E+08	0.672811	-41.0871	4.572138E-02	51.9018	8.91866	140.361	0.799886	-38.1641
5.0E+08	0.612401	-48.2370	5.194147E-02	45.5043	8.10511	133.569	0.734033	-44.5998
6.0E+08	0.557126	-54.2780	5.659943E-02	40.2112	7.35944	127.882	0.674392	-49.9370
7.0E+08	0.508133	-59.4102	6.009507E-02	35.8226	6.69712	123.102	0.622181	-54.3777
8.0E+08	0.465361	-63.8123	6.274213E-02	32.1594	6.11750	119.047	0.577269	-58.1022
9.0E+08	0.428238	-67.6313	6.477134E-02	29.0743	5.61303	115.571	0.538952	-61.2587
1.0E+09	0.396034	-70.9834	6.634791E-02	26.4506	5.17405	112.556	0.506365	-63.9647
1.1E+09	0.368032	-73.9591	6.758932E-02	24.1974	4.79104	109.913	0.478663	-66.3116
1.2E+09	0.343589	-76.6285	6.857937E-02	22.2441	4.45546	107.570	0.455091	-68.3702
1.3E+09	0.322155	-79.0462	6.937837E-02	20.5358	4.15997	105.472	0.435008	-70.1958
1.4E+09	0.303268	-81.2548	7.003020E-02	19.0293	3.89845	103.576	0.417872	-71.8314
1.5E+09	0.286542	-83.2880	7.056718E-02	17.6908	3.66577	101.849	0.403238	-73.3108
1.6E+09	0.271660	-85.1723	7.101343E-02	16.4930	3.45770	100.262	0.390735	-74.6609
1.7E+09	0.258359	-86.9292	7.138717E-02	15.4143	3.27074	98.7956	0.380056	-75.9030
1.8E+09	0.246420	-88.5759	7.170231E-02	14.4370	3.10197	97.4307	0.370947	-77.0544
1.9E+09	0.235659	-90.1265	7.196964E-02	13.5469	2.94897	96.1533	0.363195	-78.1288
2.0E+09	0.225923	-91.5925	7.219757E-02	12.7319	2.80969	94.9515	0.356623	-79.1377
2.1E+09	0.217085	-92.9836	7.239274E-02	11.9824	2.68243	93.8156	0.351081	-80.0903
2.2E+09	0.209034	-94.3076	7.256046E-02	11.2901	2.56573	92.7373	0.346442	-80.9942
2.3E+09	0.201678	-95.5713	7.270498E-02	10.6480	2.45837	91.7097	0.342599	-81.8557
2.4E+09	0.194939	-96.7803	7.282977E-02	10.0503	2.35928	90.7271	0.339458	-82.6802
2.5E+09	0.188747	-97.9395	7.293764E-02	9.49212	2.26756	89.7844	0.336942	-83.4719
2.6E+09	0.183044	-99.0530	7.303093E-02	8.96908	2.18243	88.8775	0.334982	-84.2347
2.7E+09	0.177780	-100.124	7.311157E-02	8.47753	2.10322	88.0026	0.333518	-84.9716
2.8E+09	0.172909	-101.156	7.318117E-02	8.01430	2.02934	87.1565	0.332499	-85.6853
2.9E+09	0.168394	-102.152	7.324107E-02	7.57661	1.96027	86.3366	0.331879	-86.3781
3.0E+09	0.164200	-103.114	7.329243E-02	7.16204	1.89556	85.5404	0.331620	-87.0518

 $V_{CE} = 5V$ and $I_C = 10mA$

FREQ. (Hz)	S ₁₁	PHASE(S ₁₁)	S ₁₂	PHASE(S ₁₂)	S ₂₁	PHASE(S ₂₁)	S ₂₂	PHASE(S ₂₂)
1.0E+08	0.728106	-16.4319	1.273920E-02	75.4177	15.1273	165.227	0.959692	-14.2688
2.0E+08	0.670836	-31.2669	2.342300E-02	62.8941	13.9061	152.045	0.886232	-26.9507
3.0E+08	0.600268	-43.7663	3.132521E-02	52.5891	12.3970	141.185	0.796016	-37.3172
4.0E+08	0.531768	-54.0028	3.681579E-02	44.5019	10.9257	132.570	0.708892	-45.4503
5.0E+08	0.471795	-62.3880	4.057046E-02	38.2308	9.62995	125.781	0.633146	-51.7704
6.0E+08	0.421506	-69.3569	4.316292E-02	33.3405	8.53559	120.378	0.570209	-56.7206
7.0E+08	0.379961	-75.2612	4.499071E-02	29.4764	7.62375	116.005	0.518803	-60.6598
8.0E+08	0.345693	-80.3608	4.631140E-02	26.3755	6.86423	112.398	0.476987	-63.8540
9.0E+08	0.317301	-84.8420	4.728948E-02	23.8481	6.22797	109.365	0.442915	-66.4948
1.0E+09	0.293608	-88.8381	4.803091E-02	21.7581	5.69057	106.771	0.415044	-68.7193
1.1E+09	0.273680	-92.4452	4.860515E-02	20.0070	5.23257	104.518	0.392146	-70.6269
1.2E+09	0.256782	-95.7336	4.905871E-02	18.5224	4.83873	102.532	0.373261	-72.2899
1.3E+09	0.242344	-98.7555	4.942344E-02	17.2505	4.49716	100.759	0.357640	-73.7620
1.4E+09	0.229918	-101.551	4.972158E-02	16.1506	4.19854	99.1602	0.344698	-75.0832
1.5E+09	0.219152	-104.150	4.996903E-02	15.1915	3.93554	97.7028	0.333974	-76.2840
1.6E+09	0.209767	-106.577	5.017730E-02	14.3490	3.70234	96.3629	0.325102	-77.3877
1.7E+09	0.201539	-108.851	5.035491E-02	13.6040	3.49428	95.1215	0.317789	-78.4122
1.8E+09	0.194288	-110.988	5.050825E-02	12.9411	3.30758	93.9633	0.311800	-79.3715
1.9E+09	0.187867	-113.001	5.064218E-02	12.3482	3.13919	92.8761	0.306940	-80.2768
2.0E+09	0.182157	-114.902	5.076045E-02	11.8151	2.98658	91.8500	0.303051	-81.1365
2.1E+09	0.177056	-116.698	5.086598E-02	11.3338	2.84766	90.8766	0.300003	-81.9578
2.2E+09	0.172484	-118.399	5.096107E-02	10.8974	2.72068	89.9494	0.297686	-82.7460
2.3E+09	0.168370	-120.012	5.104755E-02	10.5001	2.60420	89.0626	0.296007	-83.5057
2.4E+09	0.164656	-121.542	5.112690E-02	10.1373	2.49697	88.2115	0.294889	-84.2405
2.5E+09	0.161293	-122.996	5.120031E-02	9.80479	2.39793	87.3920	0.294266	-84.9533
2.6E+09	0.158239	-124.378	5.126876E-02	9.49919	2.30619	86.6007	0.294081	-85.6466
2.7E+09	0.155458	-125.694	5.133304E-02	9.21750	2.22098	85.8348	0.294285	-86.3223
2.8E+09	0.152919	-126.947	5.139381E-02	8.95716	2.14162	85.0916	0.294836	-86.9822
2.9E+09	0.150595	-128.140	5.145164E-02	8.71595	2.06753	84.3690	0.295696	-87.6275
3.0E+09	0.148463	-129.279	5.150697E-02	8.49194	1.99820	83.6651	0.296834	-88.2595

Typical Performance Curves

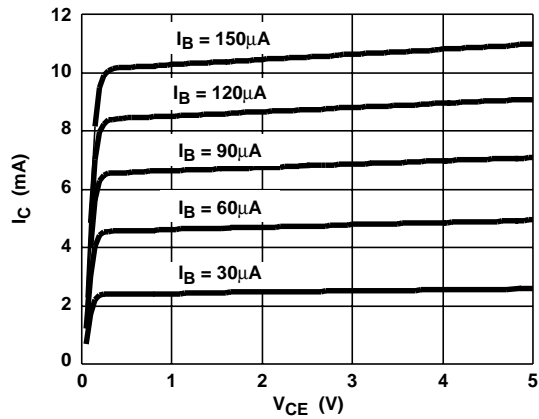

FIGURE 1. I_C vs V_{CE}

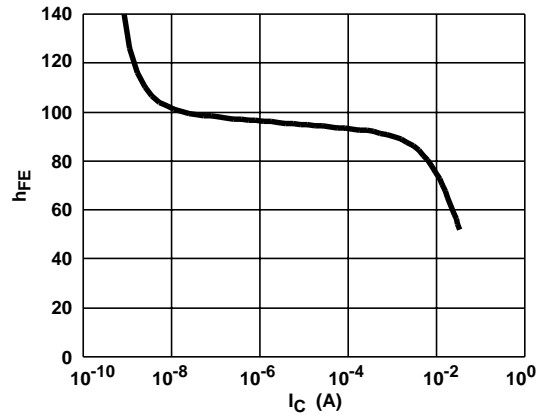

FIGURE 2. h_{FE} vs I_C

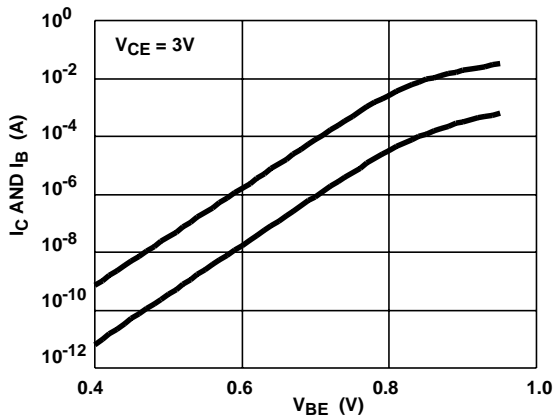

FIGURE 3. GUMMEL PLOT

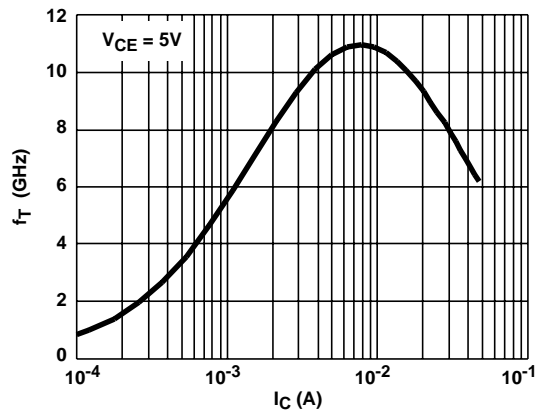

FIGURE 4. f_T vs I_C

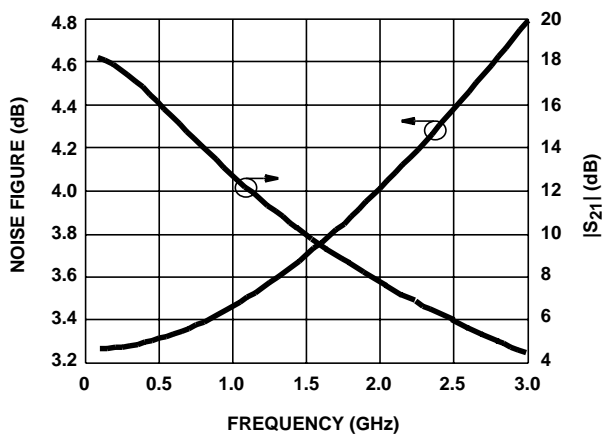

FIGURE 5. GAIN AND NOISE FIGURE vs FREQUENCY

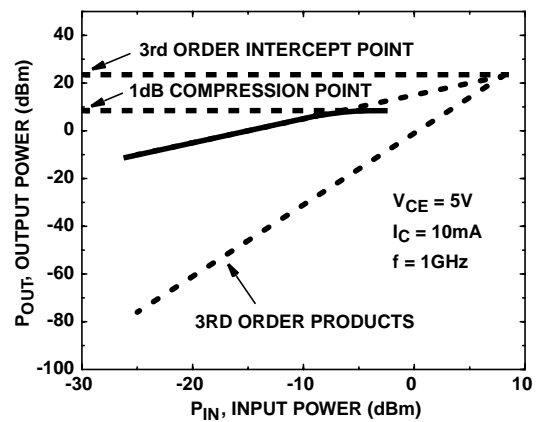

FIGURE 6. P_{1dB} AND 3RD ORDER INTERCEPT

HFA3102

Die Characteristics

PROCESS:

UHF-1

DIE DIMENSIONS:

53 mils x 52 mils x 14 mils
1340 μ m x 1320 μ m x 355.6 μ m

METALIZATION:

Type: Metal 1: AlCu(2%)/TiW
Thickness: Metal 1: 8k \AA \pm 0.5k \AA

Type: Metal 2: AlCu(2%)
Thickness: Metal 2: 16k \AA \pm 0.8k \AA

PASSIVATION:

Type: Nitride
Thickness: 4k \AA \pm 0.5k \AA

SUBSTRATE POTENTIAL (Powered Up):

Floating

Metallization Mask Layout

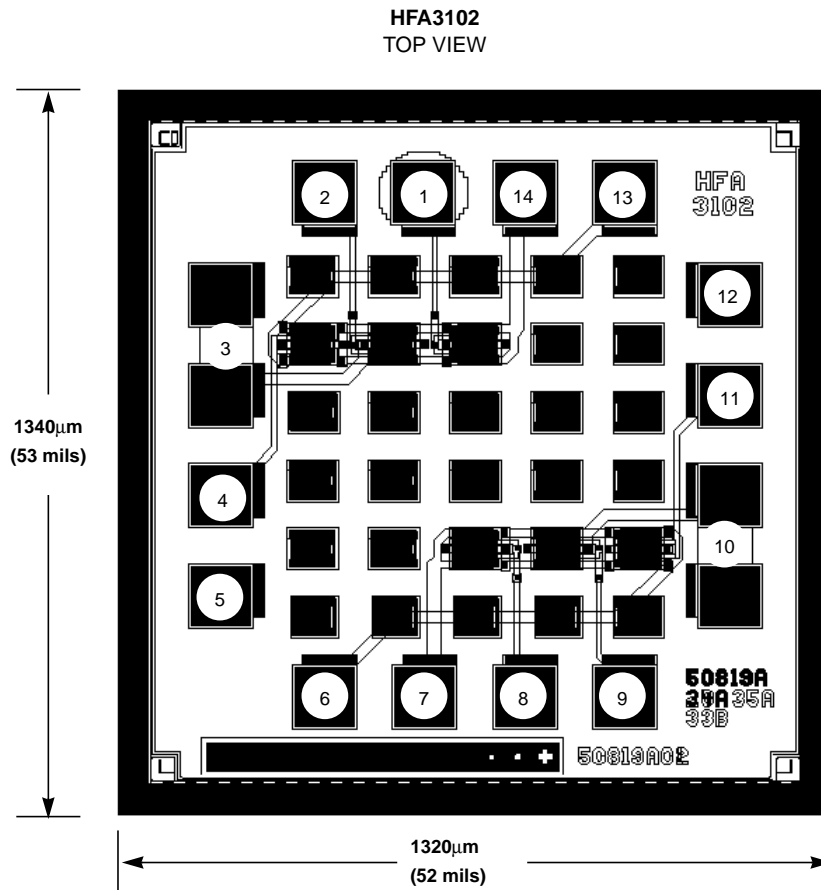

Pad numbers correspond to the 14 pin SOIC pinout.

All Intersil semiconductor products are manufactured, assembled and tested under **ISO9000** quality systems certification.

Intersil semiconductor products are sold by description only. Intersil Corporation reserves the right to make changes in circuit design and/or specifications at any time without notice. Accordingly, the reader is cautioned to verify that data sheets are current before placing orders. Information furnished by Intersil is believed to be accurate and reliable. However, no responsibility is assumed by Intersil or its subsidiaries for its use; nor for any infringements of patents or other rights of third parties which may result from its use. No license is granted by implication or otherwise under any patent or patent rights of Intersil or its subsidiaries.

For information regarding Intersil Corporation and its products, see web site <http://www.intersil.com>