

SS8050

NPN Epitaxial Silicon Transistor

Features

- 2W Output Amplifier of Portable Radios in Class B Push-pull Operation.
- Complimentary to SS8550
- Collector Current: $I_C=1.5A$
- Collector Power Dissipation: $P_C=2W$ ($T_C=25^\circ C$)

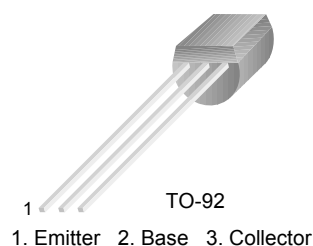

Absolute Maximum Ratings $T_a = 25^\circ C$ unless otherwise noted

Symbol	Parameter	Value	Units
V_{CBO}	Collector-Base Voltage	40	V
V_{CEO}	Collector-Emitter Voltage	25	V
V_{EBO}	Emitter-Base Voltage	6	V
I_C	Collector Current	1.5	A
P_C	Collector Power Dissipation	1	W
T_J	Junction Temperature	150	$^\circ C$
T_{STG}	Storage Temperature	-65 ~ 150	$^\circ C$

Electrical Characteristics $T_a = 25^\circ C$ unless otherwise noted

Symbol	Parameter	Conditions	Min.	Typ.	Max.	Units
BV_{CBO}	Collector-Base Breakdown Voltage	$I_C=100\mu A, I_E=0$	40			V
BV_{CEO}	Collector-Emitter Breakdown Voltage	$I_C=2mA, I_B=0$	25			V
BV_{EBO}	Emitter-Base Breakdown Voltage	$I_E=100\mu A, I_C=0$	6			V
I_{CBO}	Collector Cut-off Current	$V_{CB}=35V, I_E=0$			100	nA
I_{EBO}	Emitter Cut-off Current	$V_{EB}=6V, I_C=0$			100	nA
h_{FE1} h_{FE2} h_{FE3}	DC Current Gain	$V_{CE}=1V, I_C=5mA$ $V_{CE}=1V, I_C=100mA$ $V_{CE}=1V, I_C=800mA$	45 85 40		300	
$V_{CE(sat)}$	Collector-Emitter Saturation Voltage	$I_C=800mA, I_B=80mA$			0.5	V
$V_{BE(sat)}$	Base-Emitter Saturation Voltage	$I_C=800mA, I_B=80mA$			1.2	V
$V_{BE(on)}$	Base-Emitter On Voltage	$V_{CE}=1V, I_C=10mA$			1	V
C_{ob}	Output Capacitance	$V_{CB}=10V, I_E=0, f=1MHz$		9.0		pF
f_T	Current Gain Bandwidth Product	$V_{CE}=10V, I_C=50mA$	100			MHz

h_{FE} Classification

Classification	B	C	D
h_{FE2}	85 ~ 160	120 ~ 200	160 ~ 300

Typical Performance Characteristics

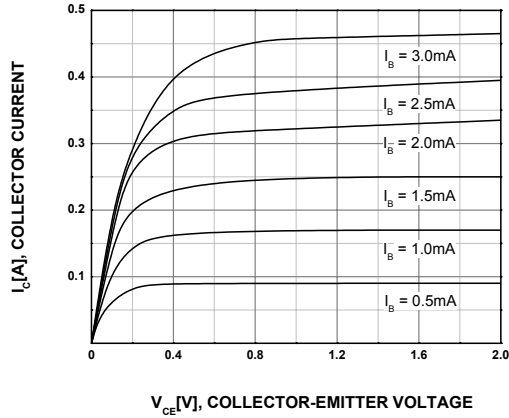

Figure 1. Static Characteristic

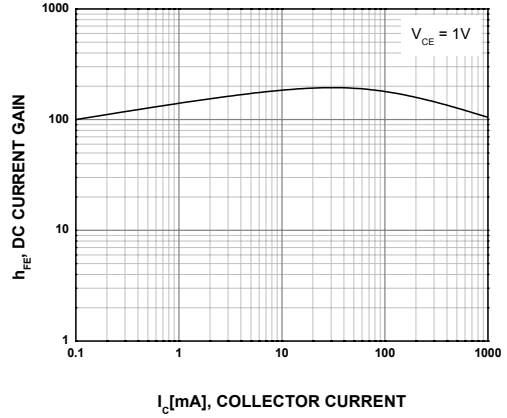

Figure 2. DC current Gain

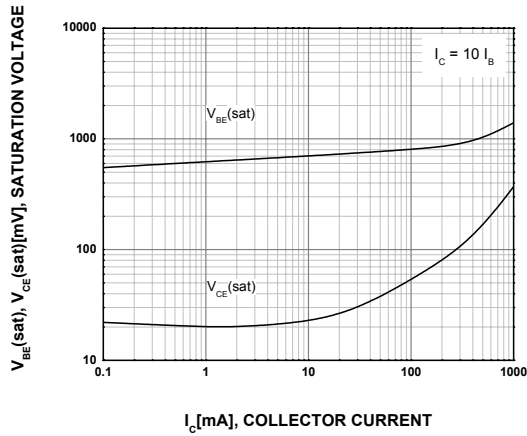

Figure 3. Base-Emitter Saturation Voltage
Collector-Emitter Saturation Voltage

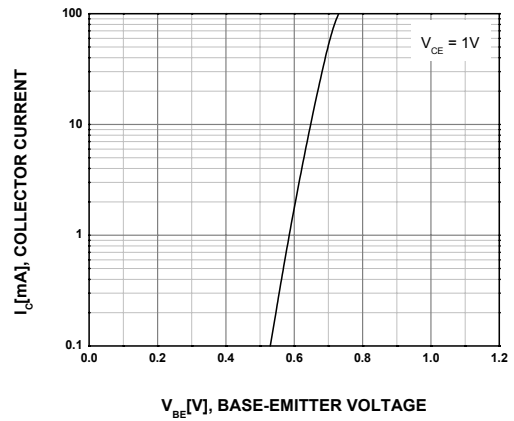

Figure 4. Base-Emitter On Voltage

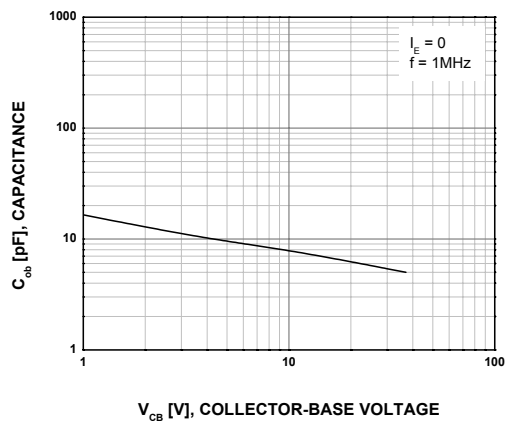

Figure 5. Collector Output Capacitance

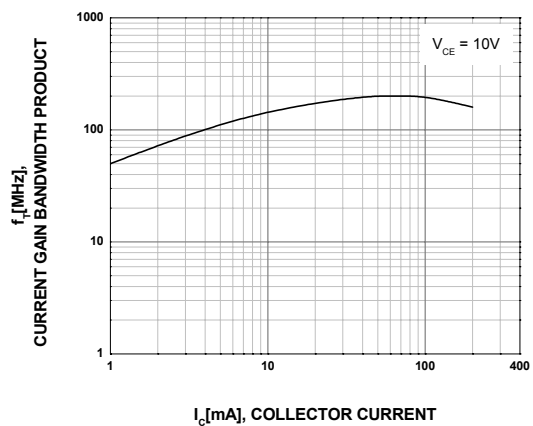
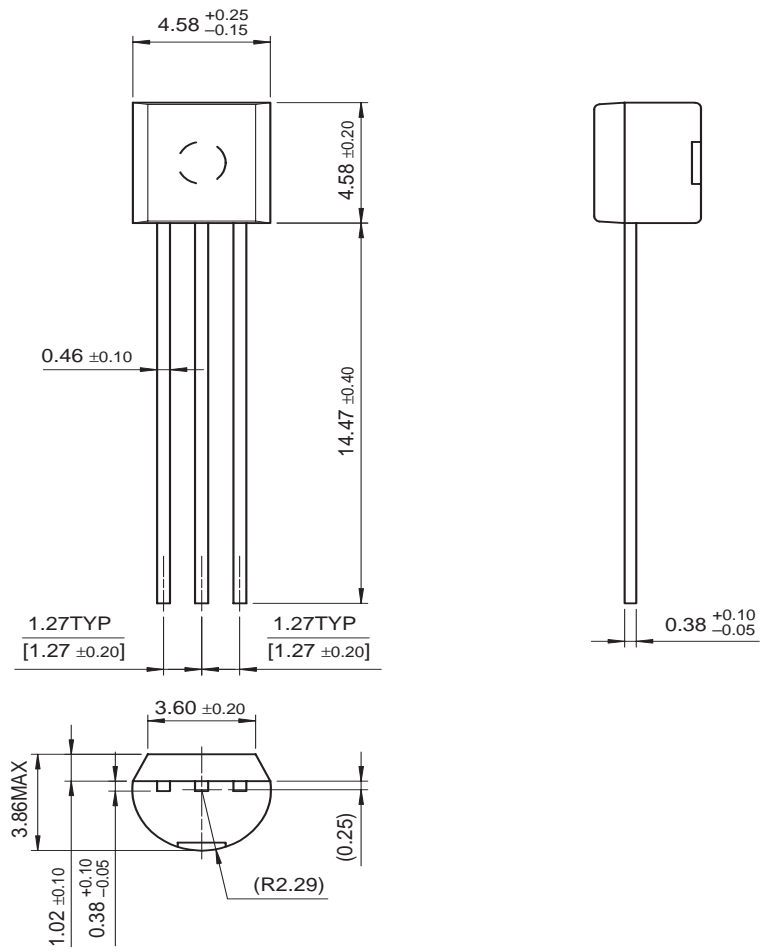

Figure 6. Current Gain Bandwidth Product

Physical Dimensions

TO-92



Dimensions in Millimeters