



# STP7NK30Z STF7NK30Z

## N-CHANNEL 300V - 0.80Ω - 5A TO-220/TO-220FP Zener-Protected SuperMESH™ Power MOSFET

TYPE	V <sub>DSS</sub>	R <sub>DS(on)</sub>	I <sub>D</sub>	P <sub>w</sub>
STP7NK30Z	300 V	< 0.9 Ω	5 A	50 W
STF7NK30Z	300 V	< 0.9 Ω	5 A	20 W

- TYPICAL R<sub>DS(on)</sub> = 0.80 Ω
- EXTREMELY HIGH dv/dt CAPABILITY
- 100% AVALANCHE TESTED
- GATE CHARGE MINIMIZED
- VERY LOW INTRINSIC CAPACITANCES
- VERY GOOD MANUFACTURING REPEATABILITY

### DESCRIPTION

The SuperMESH™ series is obtained through an extreme optimization of ST's well established strip-based PowerMESH™ layout. In addition to pushing on-resistance significantly down, special care is taken to ensure a very good dv/dt capability for the most demanding applications. Such series complements ST full range of high voltage MOSFETs including revolutionary MDmesh™ products.

### APPLICATIONS

- HIGH CURRENT, HIGH SPEED SWITCHING
- IDEAL FOR OFF-LINE POWER SUPPLIES, ADAPTORS AND PFC
- LIGHTING

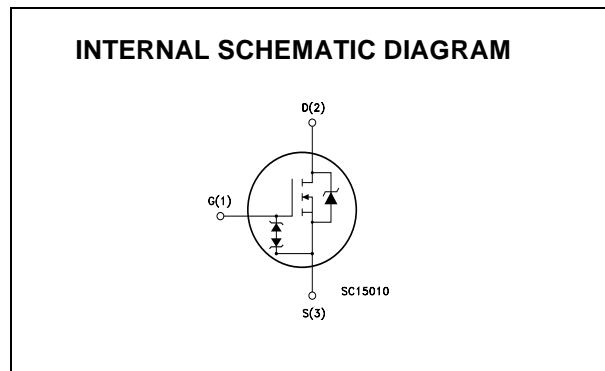
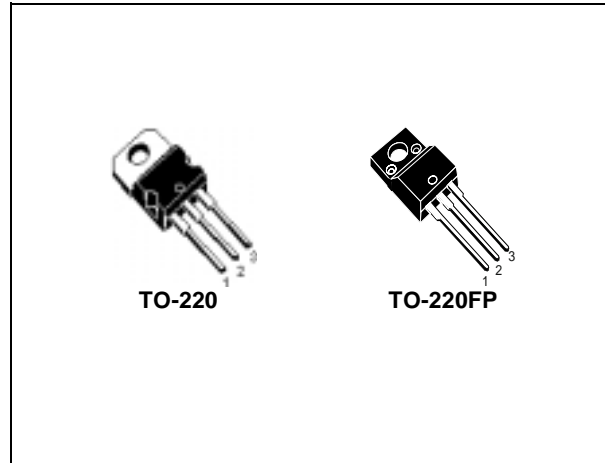

### ORDER CODES

PART NUMBER	MARKING	PACKAGE	PACKAGING
STP7NK30Z	P7NK30Z	TO-220	TUBE
STF7NK30Z	F7NK30Z	TO-220FP	TUBE

## STP7NK30Z - STF7NK30Z

### ABSOLUTE MAXIMUM RATINGS

Symbol	Parameter	Value		Unit
		STP7NK30Z	STF7NK30Z	
V <sub>DS</sub>	Drain-source Voltage (V <sub>GS</sub> = 0)	300		V
V <sub>DGR</sub>	Drain-gate Voltage (R <sub>GS</sub> = 20 kΩ)	300		V
V <sub>GS</sub>	Gate- source Voltage	± 30		V
I <sub>D</sub>	Drain Current (continuous) at T <sub>C</sub> = 25°C	5	5 (*)	A
I <sub>D</sub>	Drain Current (continuous) at T <sub>C</sub> = 100°C	3.2	3.2 (*)	A
I <sub>DM</sub> (•)	Drain Current (pulsed)	20	20 (*)	A
P <sub>TOT</sub>	Total Dissipation at T <sub>C</sub> = 25°C	50	20	W
	Derating Factor	0.4	0.16	W/°C
V <sub>ESD(G-S)</sub>	Gate source ESD(HBM-C=100pF, R=1.5KΩ)	2800		V
dv/dt (1)	Peak Diode Recovery voltage slope	4.5		V/ns
V <sub>ISO</sub>	Insulation Withstand Voltage (DC)	-	2500	V
T <sub>j</sub> T <sub>stg</sub>	Operating Junction Temperature Storage Temperature	-55 to 150 -55 to 150		°C °C

(•) Pulse width limited by safe operating area

(1) I<sub>SD</sub> ≤ 5.7A, di/dt ≤ 200A/μs, V<sub>DD</sub> ≤ V<sub>(BR)DSS</sub>, T<sub>j</sub> ≤ T<sub>JMAX</sub>.

(\*) Limited only by maximum temperature allowed

### THERMAL DATA

		TO-220	TO-220FP	
R <sub>thj-case</sub>	Thermal Resistance Junction-case Max	2.50	6.25	°C/W
R <sub>thj-amb</sub>	Thermal Resistance Junction-ambient Max	62.5		°C/W
T <sub>I</sub>	Maximum Lead Temperature For Soldering Purpose	300		°C

### AVALANCHE CHARACTERISTICS

Symbol	Parameter	Max Value	Unit
I <sub>AR</sub>	Avalanche Current, Repetitive or Not-Repetitive (pulse width limited by T <sub>j</sub> max)	5	A
E <sub>AS</sub>	Single Pulse Avalanche Energy (starting T <sub>j</sub> = 25 °C, I <sub>D</sub> = I <sub>AR</sub> , V <sub>DD</sub> = 50 V)	130	mJ

### GATE-SOURCE ZENER DIODE

Symbol	Parameter	Test Conditions	Min.	Typ.	Max.	Unit
BV <sub>GSO</sub>	Gate-Source Breakdown Voltage	I <sub>gs</sub> = ± 1mA (Open Drain)	30			V

### PROTECTION FEATURES OF GATE-TO-SOURCE ZENER DIODES

The built-in back-to-back Zener diodes have specifically been designed to enhance not only the device's ESD capability, but also to make them safely absorb possible voltage transients that may occasionally be applied from gate to source. In this respect the Zener voltage is appropriate to achieve an efficient and cost-effective intervention to protect the device's integrity. These integrated Zener diodes thus avoid the usage of external components.

**ELECTRICAL CHARACTERISTICS** ( $T_{CASE} = 25^{\circ}C$  UNLESS OTHERWISE SPECIFIED)  
ON/OFF

Symbol	Parameter	Test Conditions	Min.	Typ.	Max.	Unit
$V_{(BR)DSS}$	Drain-source Breakdown Voltage	$I_D = 1 \text{ mA}, V_{GS} = 0$	300			V
$I_{DSS}$	Zero Gate Voltage Drain Current ( $V_{GS} = 0$ )	$V_{DS} = \text{Max Rating}$ $V_{DS} = \text{Max Rating}, T_C = 125^{\circ}C$			1 50	$\mu A$ $\mu A$
$I_{GSS}$	Gate-body Leakage Current ( $V_{DS} = 0$ )	$V_{GS} = \pm 20V$			$\pm 10$	$\mu A$
$V_{GS(th)}$	Gate Threshold Voltage	$V_{DS} = V_{GS}, I_D = 50\mu A$	3	3.75	4.5	V
$R_{DS(on)}$	Static Drain-source On Resistance	$V_{GS} = 10V, I_D = 2.5 \text{ A}$		0.80	0.90	$\Omega$

## DYNAMIC

Symbol	Parameter	Test Conditions	Min.	Typ.	Max.	Unit
$g_{fs} (1)$	Forward Transconductance	$V_{DS} = 15 \text{ V}, I_D = 2.5 \text{ A}$		2.5		S
$C_{iss}$ $C_{oss}$ $C_{rss}$	Input Capacitance Output Capacitance Reverse Transfer Capacitance	$V_{DS} = 25V, f = 1 \text{ MHz}, V_{GS} = 0$		380 74 15		pF pF pF
$C_{oss \text{ eq.}} (3)$	Equivalent Output Capacitance	$V_{GS} = 0V, V_{DS} = 0V \text{ to } 400V$		30		pF

## SWITCHING ON

Symbol	Parameter	Test Conditions	Min.	Typ.	Max.	Unit
$t_{d(on)}$ $t_r$	Turn-on Delay Time Rise Time	$V_{DD} = 200 \text{ V}, I_D = 4.5 \text{ A}$ $R_G = 4.7\Omega, V_{GS} = 10 \text{ V}$ (Resistive Load see, Figure 3)		11 25		ns ns
$Q_g$ $Q_{gs}$ $Q_{gd}$	Total Gate Charge Gate-Source Charge Gate-Drain Charge	$V_{DD} = 320V, I_D = 5 \text{ A},$ $V_{GS} = 10V$		13 4.5 7.6	17	nC nC nC

## SWITCHING OFF

Symbol	Parameter	Test Conditions	Min.	Typ.	Max.	Unit
$t_{d(off)}$ $t_f$	Turn-off Delay Time Fall Time	$V_{DD} = 200 \text{ V}, I_D = 1.5A$ $R_G = 4.7\Omega, V_{GS} = 10 \text{ V}$ (Resistive Load see, Figure 3)		20 10		ns ns
$t_r(V_{off})$ $t_f$ $t_c$	Off-voltage Rise Time Fall Time Cross-over Time	$V_{DD} = 320V, I_D = 5A,$ $R_G = 4.7\Omega, V_{GS} = 10V$ (Inductive Load see, Figure 5)		8.5 8.5 20		ns ns ns

## SOURCE DRAIN DIODE

Symbol	Parameter	Test Conditions	Min.	Typ.	Max.	Unit
$I_{SD}$ $I_{SDM} (2)$	Source-drain Current Source-drain Current (pulsed)				5 20	A A
$V_{SD} (1)$	Forward On Voltage	$I_{SD} = 5 \text{ A}, V_{GS} = 0$			1.6	V
$t_{rr}$ $Q_{rr}$ $I_{RRM}$	Reverse Recovery Time Reverse Recovery Charge Reverse Recovery Current	$I_{SD} = 5 \text{ A}, di/dt = 100A/\mu s$ $V_{DD} = 40, T_j = 150^{\circ}C$ (see test circuit, Figure 5)		154 716 9.3		ns nC A

Note: 1. Pulsed: Pulse duration = 300  $\mu s$ , duty cycle 1.5 %.

2. Pulse width limited by safe operating area.

3.  $C_{oss \text{ eq.}}$  is defined as a constant equivalent capacitance giving the same charging time as  $C_{oss}$  when  $V_{DS}$  increases from 0 to 80%  $V_{DSS}$ .

Safe Operating Area for TO-220

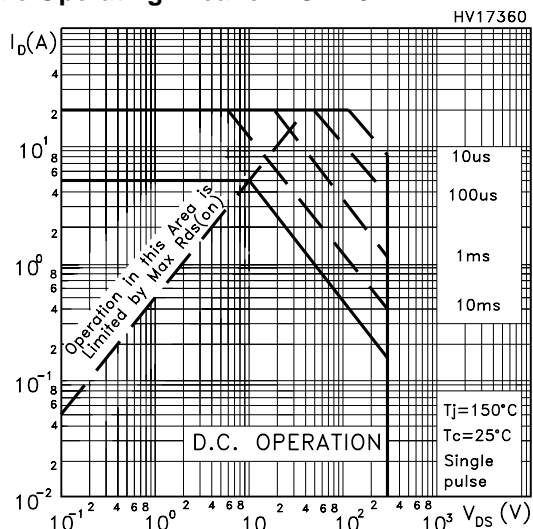

Safe Operating Area for TO-220FP

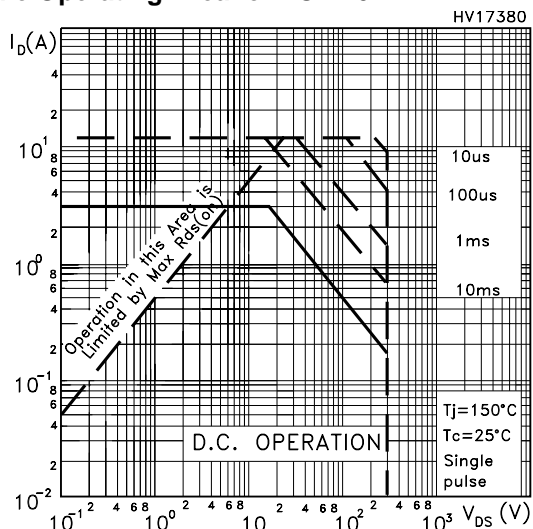

Thermal Impedance for TO-220

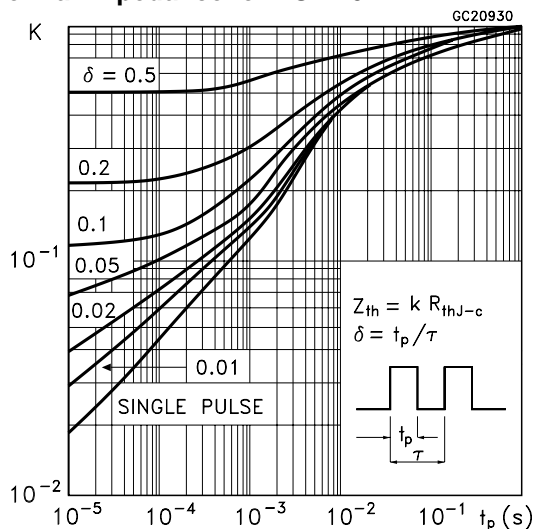

Thermal Impedance for TO-220FP

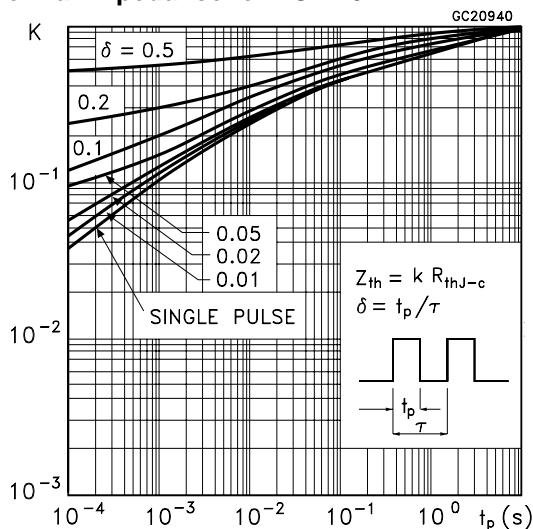

Output Characteristics

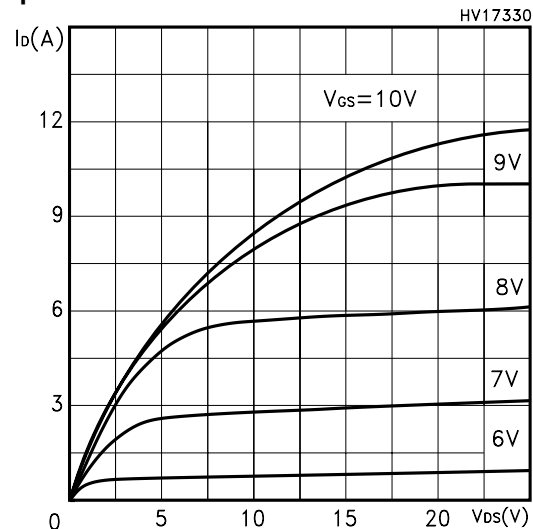

Transfer Characteristics

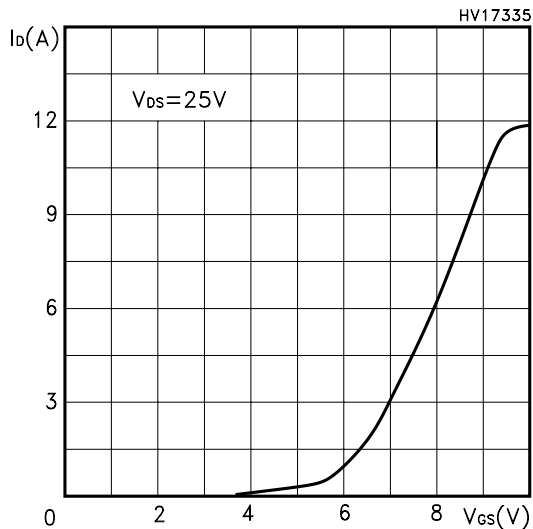

**Transconductance**

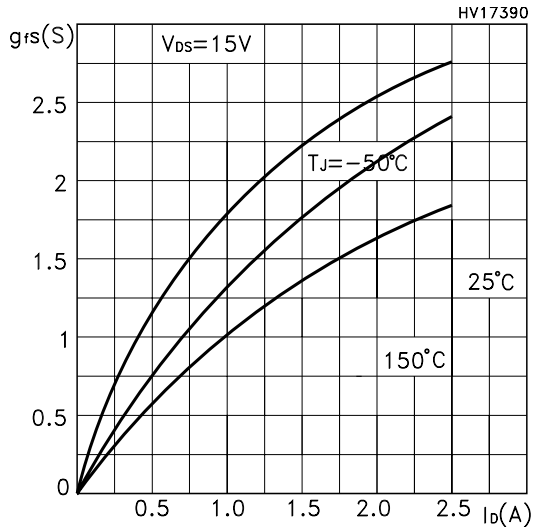

**Static Drain-source On Resistance**

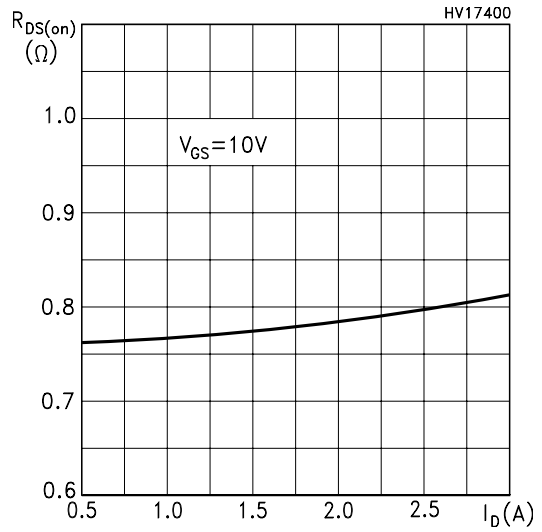

**Gate Charge vs Gate-source Voltage**

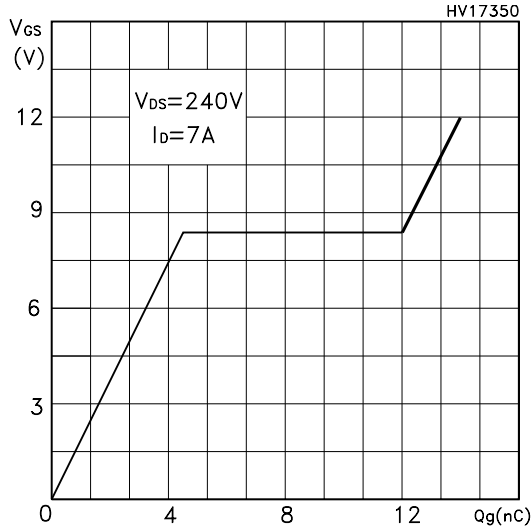

**Capacitance Variations**

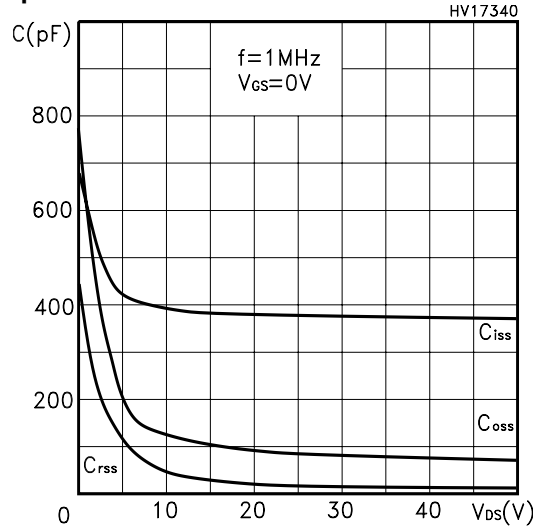

**Normalized Gate Threshold Voltage vs Temp.**

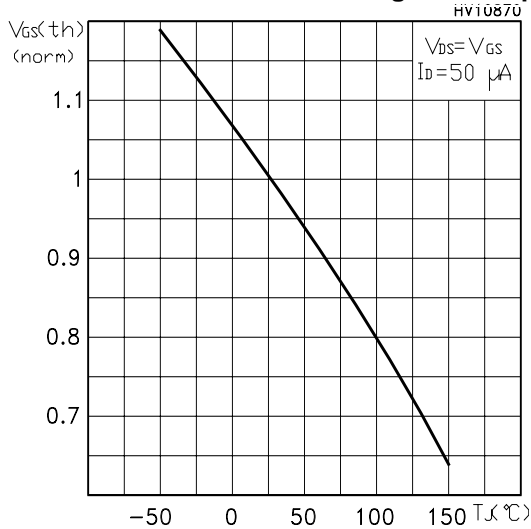

**Normalized On Resistance vs Temperature**

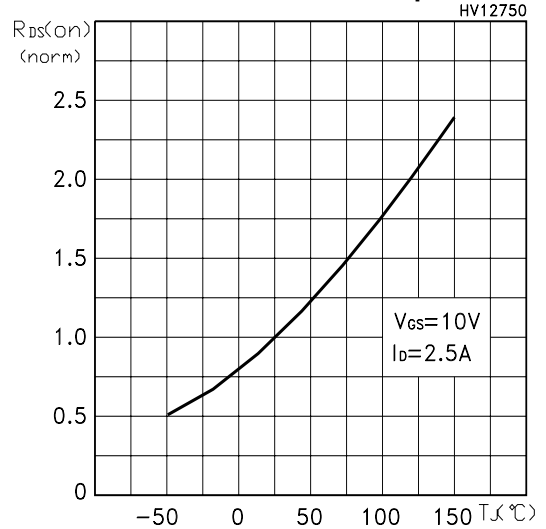

Source-drain Diode Forward Characteristics

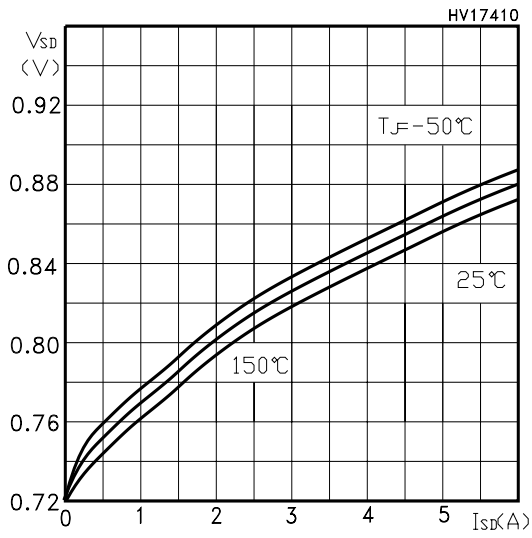

Normalized BVDSS vs Temperature

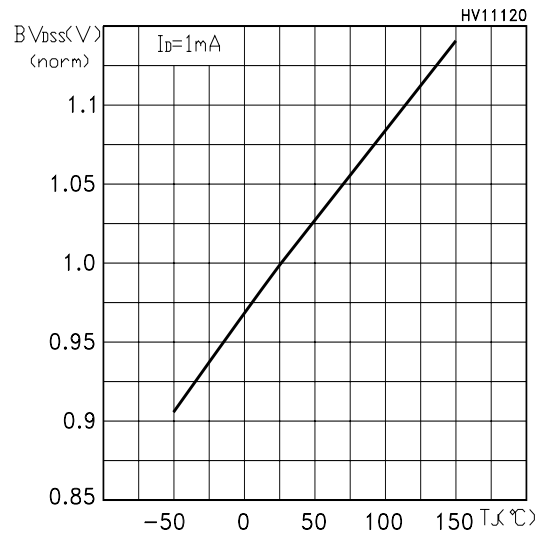

**Fig. 1: Unclamped Inductive Load Test Circuit**



**Fig. 2: Unclamped Inductive Waveform**



**Fig. 3: Switching Times Test Circuit For Resistive Load**



**Fig. 4: Gate Charge test Circuit**

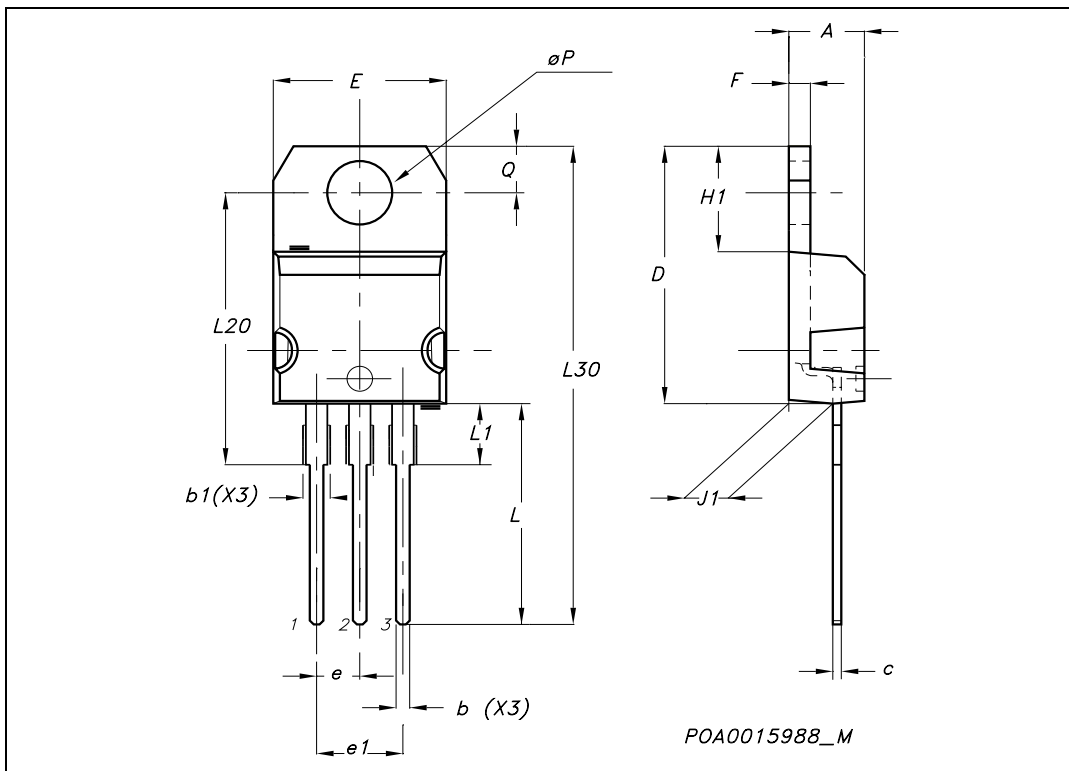

**Fig. 5: Test Circuit For Inductive Load Switching And Diode Recovery Times**



**TO-220 MECHANICAL DATA**

DIM.	mm.			inch		
	MIN.	TYP.	MAX.	MIN.	TYP.	MAX.
A	4.40		4.60	0.173		0.181
b	0.61		0.88	0.024		0.034
b1	1.15		1.70	0.045		0.066
c	0.49		0.70	0.019		0.027
D	15.25		15.75	0.60		0.620
E	10		10.40	0.393		0.409
e	2.40		2.70	0.094		0.106
e1	4.95		5.15	0.194		0.202
F	1.23		1.32	0.048		0.052
H1	6.20		6.60	0.244		0.256
J1	2.40		2.72	0.094		0.107
L	13		14	0.511		0.551
L1	3.50		3.93	0.137		0.154
L20		16.40			0.645	
L30		28.90			1.137	
øP	3.75		3.85	0.147		0.151
Q	2.65		2.95	0.104		0.116





**TO-220FP MECHANICAL DATA**

DIM.	mm.			inch		
	MIN.	TYP	MAX.	MIN.	TYP.	MAX.
A	4.4		4.6	0.173		0.181
B	2.5		2.7	0.098		0.106
D	2.5		2.75	0.098		0.108
E	0.45		0.7	0.017		0.027
F	0.75		1	0.030		0.039
F1	1.15		1.7	0.045		0.067
F2	1.15		1.7	0.045		0.067
G	4.95		5.2	0.195		0.204
G1	2.4		2.7	0.094		0.106
H	10		10.4	0.393		0.409
L2		16			0.630	
L3	28.6		30.6	1.126		1.204
L4	9.8		10.6	.0385		0.417
L5	2.9		3.6	0.114		0.141
L6	15.9		16.4	0.626		0.645
L7	9		9.3	0.354		0.366
∅	3		3.2	0.118		0.126

